

Features

- APD with 0.2 mm² active area
- Slow multiplication curve
- QE > 80% @ 750 nm-910 nm
- Fast rise time, low noise
- Optimum gain: 50-60

Description

Circular active area APD chip with NIR enhanced sensitivity. Ceramic carrier type non hermetic SMD package with clear glass or filter window. Reflow solderable.

Application

- Laser range finder
- High speed photometry
- High speed optical communications
- Medical equipment

RoHS

2002/95/EC



Absolute maximum ratings

Symbol	Parameter	Min	Max	Unit
T _{STG}	Storage temp	-40	100	°C
T _{OP}	Operating temp	-20	70	°C
M _{max}	Gain (I _{PO} = 1 nA)	200		
I _{PEAK}	Peak DC current		0.25	mA

Spectral response (M = 100)

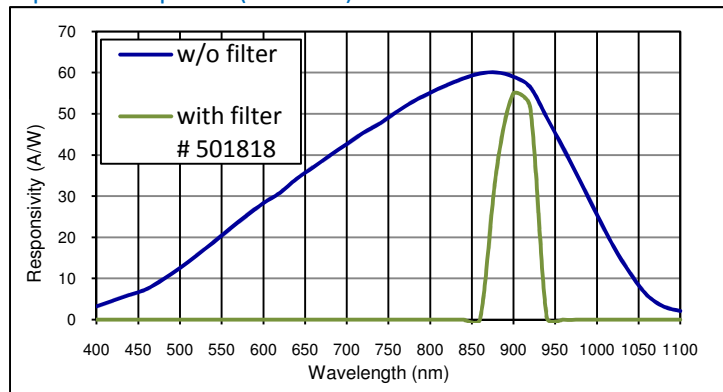

Schematic

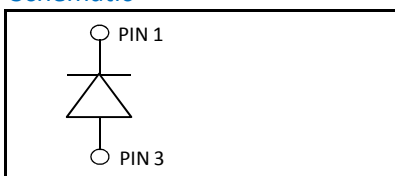

Electro-optical characteristics @ 22°C

Symbol	Characteristic	Test Condition	Min	Typ	Max	Unit
	Active area		diameter 500			µm
	Active area		0.196			mm ²
I _D	Dark current	M = 100		0.8	5.0	nA
C	Capacitance	M = 100		1.2		pF
	Responsivity	M = 100; λ = 905 nm	48	52		A/W
	Responsivity with filter	Article 501818 ; M = 100; λ = 905 nm	38	49		A/W
t _R	Rise time	M = 100; λ = 905 nm; R _L = 50 Ω		0.55		ns
	Cut-off frequency	-3dB		0.5		GHz
V _{BR}	Breakdown voltage	I _R = 2 µA, V _{BR} - binning available	160		240	V
	Temperature coefficient	Change of V _{BR} with temperature	1.25		1.55	V/K
	Excess noise factor	M = 100		2.5		
	Excess noise index	M = 100		0.2		
	N.E.P.	M = 100; λ = 800 nm		2 E-14		W/√Hz
	Noise current	M = 100; λ = 800 nm		1.0		pA/√Hz

European, International Sales:



International AG

Silicon Sensor International AG
 Peter-Behrens-Strasse 15
 12459 Berlin
 Germany
 Phone: +49-30-6399-2399
 Fax: +49-30-6399-23752
 E-Mail: sales@silicon-sensor.com

USA:



Pacific Silicon Sensor, Inc.
 5700 Corsa Avenue #105
 Westlake Village
 CA 91362 USA
 Phone: +1-818-706-3400
 Fax: +1-818-889-7053
 E-Mail: sales@pacific-sensor.com

Quantum efficiency (22 °C)

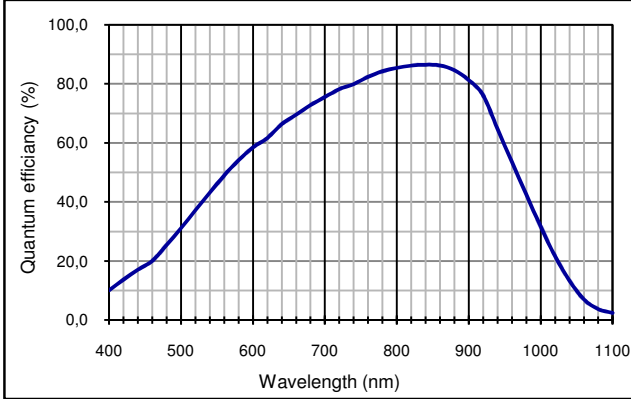

Capacitance as fct of reverse bias (22 °C)

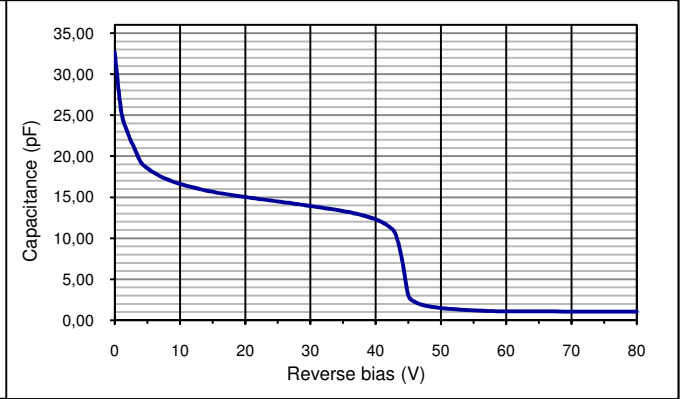

Multiplication as fct of bias (22 °C)

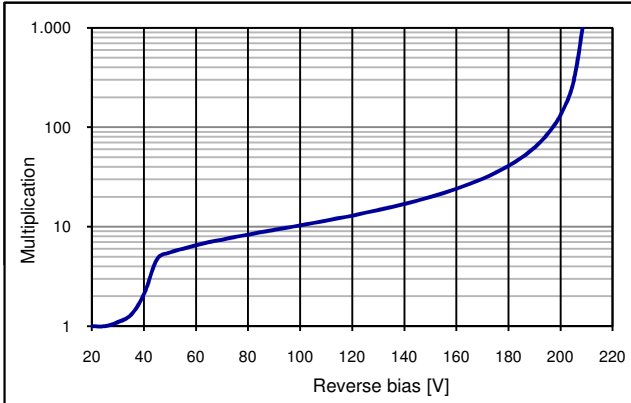

Dark current as fct of bias (22 °C)

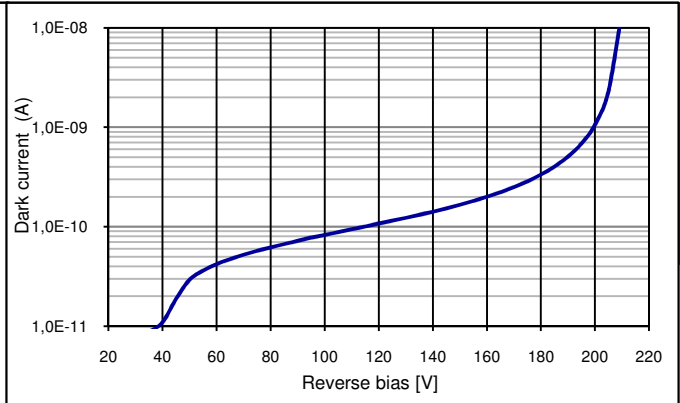

Filter characteristics 905 nm band pass (#501818)

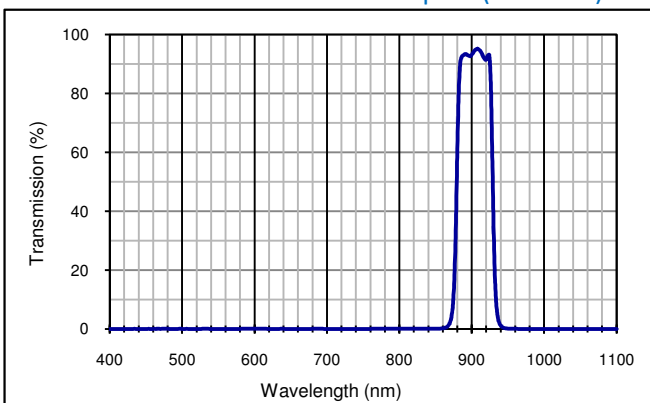

European, International Sales:



Silicon Sensor International AG
 Peter-Behrens-Strasse 15
 12459 Berlin
 Germany
 Phone: +49-30-6399-2399
 Fax: +49-30-6399-23752
 E-Mail: sales@silicon-sensor.com

USA:



Pacific Silicon Sensor, Inc.
 5700 Corsa Avenue #105
 Westlake Village
 CA 91362 USA
 Phone: +1-818-706-3400
 Fax: +1-818-889-7053
 E-Mail: sales@pacific-sensor.com

Package dimension, large quantities on reel

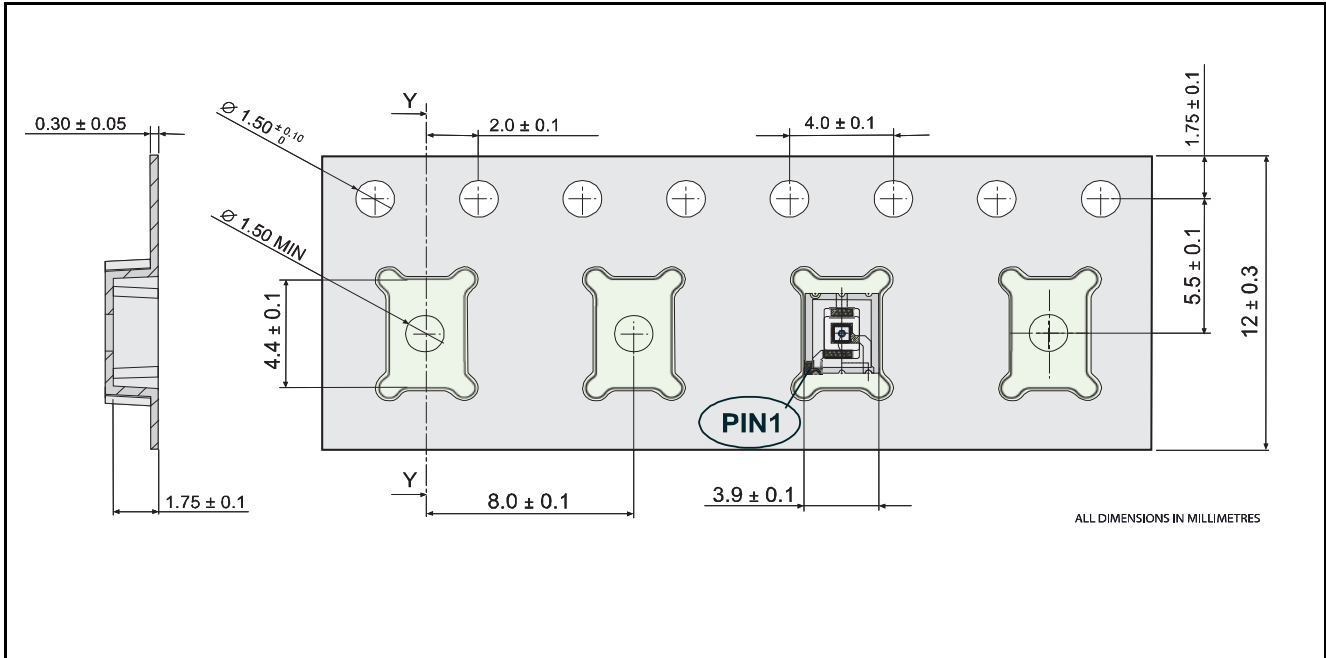

Package dimension, small quantities in trays

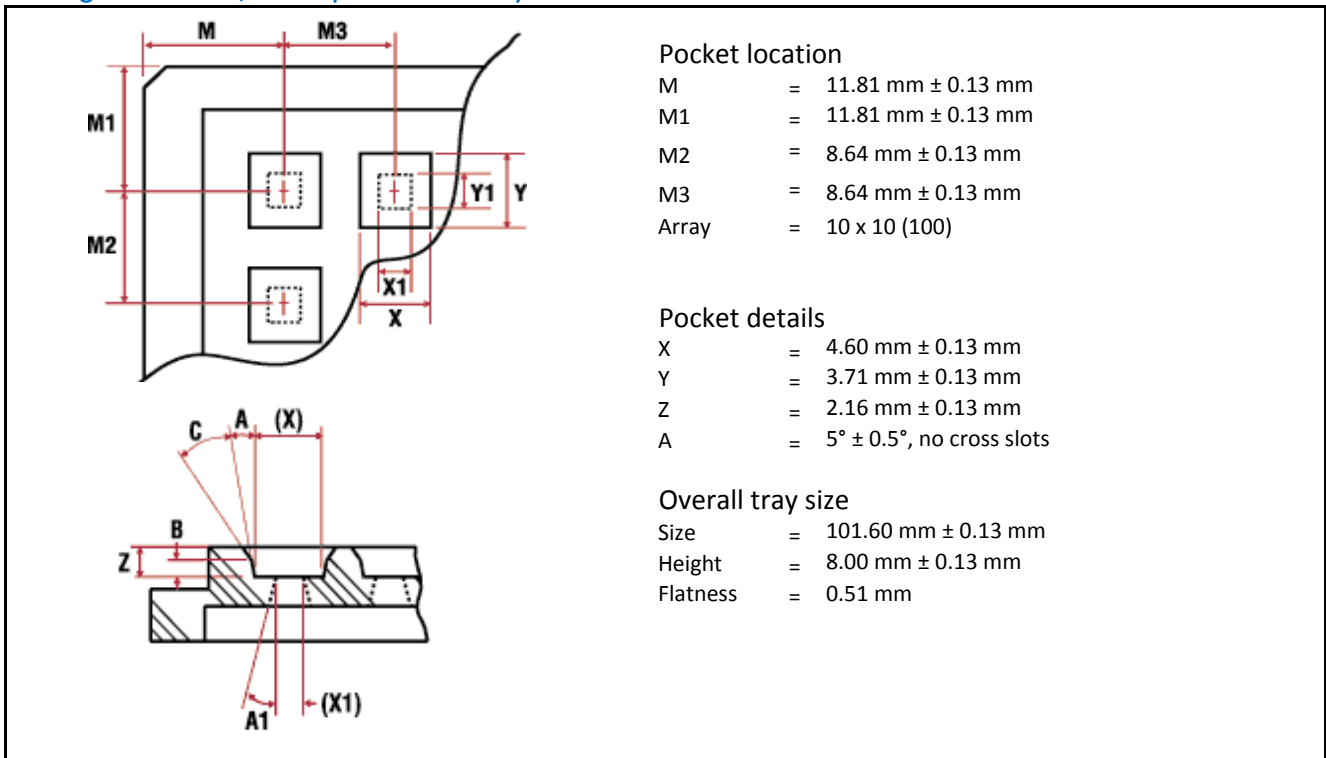

Disclaimer: Due to our strive for continuous improvement, specifications are subject to change within our PCN policy according to JESD46C.

European, International Sales:



Silicon Sensor International AG

Silicon Sensor International AG
 Peter-Behrens-Strasse 15
 12459 Berlin
 Germany
 Phone: +49-30-6399-2399
 Fax: +49-30-6399-23752
 E-Mail: sales@silicon-sensor.com

USA:



Pacific Silicon Sensor, Inc.
 5700 Corsa Avenue #105
 Westlake Village
 CA 91362 USA
 Phone: +1-818-706-3400
 Fax: +1-818-889-7053
 E-Mail: sales@pacific-sensor.com