

**Features**

- APD with 0.2mm<sup>2</sup> active area
- 500µm diameter active area
- High gain at low bias voltage
- Fast rise time, low capacitance
- Optimum gain: 50-60

**Description**

Circular active area APD chip with 500µm diameter. Ceramic carrier type non hermetic SMD package with clear glass or filter window. Reflow solderable.

**Application**

- Laser range finder
- High speed photometry
- High speed optical communications
- Medical equipment

**RoHS**

2002/95/EC



**Absolute maximum ratings**

Symbol	Parameter	Min	Max	Unit
T <sub>STG</sub>	Storage temp	-40	100	°C
T <sub>OP</sub>	Operating temp	-20	70	°C
M <sub>max</sub>	Gain (I <sub>PO</sub> = 1 nA)		200	
I <sub>PEAK</sub>	Peak DC current		0.25	mA

**Spectral response (M = 100)**

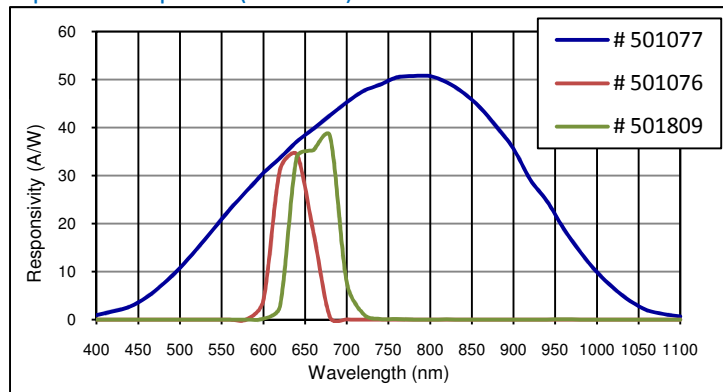

**Schematic**

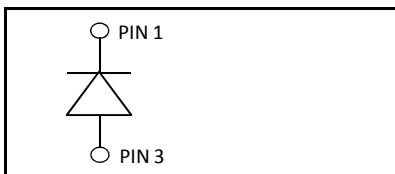

**Electro-optical characteristics @ 22°C**

Symbol	Characteristic	Test Condition	Min	Typ	Max	Unit
	Active area		diameter 500			µm
	Active area		0.196			mm <sup>2</sup>
I <sub>D</sub>	Dark current	M = 100		0.5	2.0	nA
C	Capacitance	M = 100		2.2		pF
	Responsivity	Order # <b>501077</b> ; M = 100; λ = 800 nm	45	50		A/W
	Responsivity	Order # <b>501076</b> ; M = 100; λ = 635 nm	30	32		A/W
	Responsivity, preliminary	Order # <b>501809</b> ; M = 100; λ = 650 nm	30	35		A/W
t <sub>R</sub>	Rise time	M = 100; λ = 905 nm; R <sub>L</sub> = 50 Ω		0.35		ns
	Cut-off frequency	-3dB		1		GHz
V <sub>BR</sub>	Breakdown voltage	I <sub>R</sub> = 2 µA, V <sub>BR</sub> - binning available	80		200	V
	Temperature coefficient	Change of V <sub>BR</sub> with temperature		0.45		V/K
	Excess noise factor	M = 100		2.2		
	Excess noise index	M = 100		0.2		
	N.E.P.	M = 100; λ = 800 nm		2 E-14		W/√Hz
	Noise current	M = 100; λ = 800 nm		1.0		pA/√Hz

**European, International Sales:**



International AG

Silicon Sensor International AG  
Peter-Behrens-Strasse 15  
12459 Berlin  
Germany  
Phone: +49-30-6399-2399  
Fax: +49-30-6399-23752  
E-Mail: sales@silicon-sensor.com

**USA:**



Pacific Silicon Sensor, Inc.  
5700 Corsa Avenue #105  
Westlake Village  
CA 91362 USA  
Phone: +1-818-706-3400  
Fax: +1-818-889-7053  
E-Mail: sales@pacific-sensor.com

Quantum efficiency (22 °C)

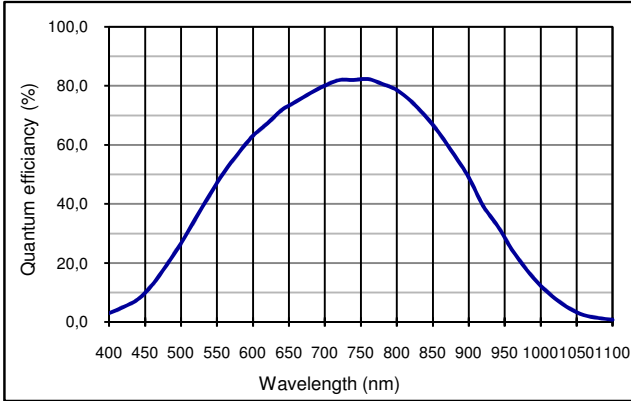

Capacitance as fct of reverse bias (22 °C)

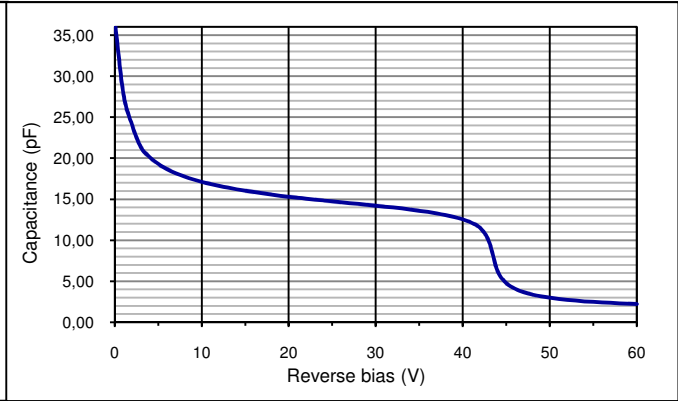

Multiplication as fct of bias (22 °C)

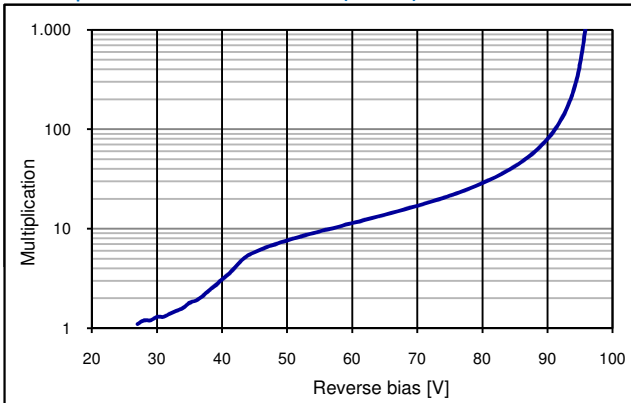

Dark current as fct of bias (22 °C)

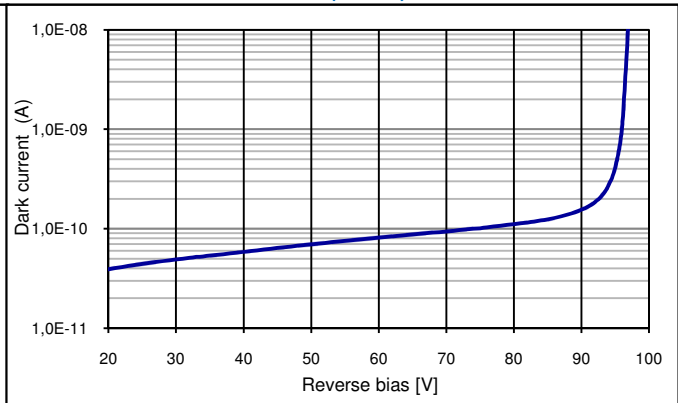

Order # 501076:

Typ. filter characteristics (center 635 nm)

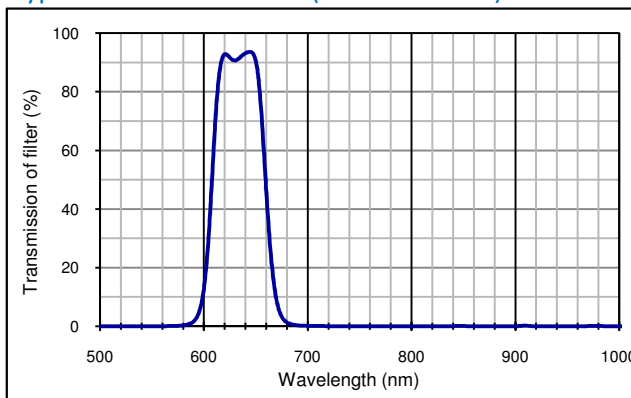

full filter specification upon request

Order # 501809, preliminary specification:

Typ. filter characteristics (center 650 nm)

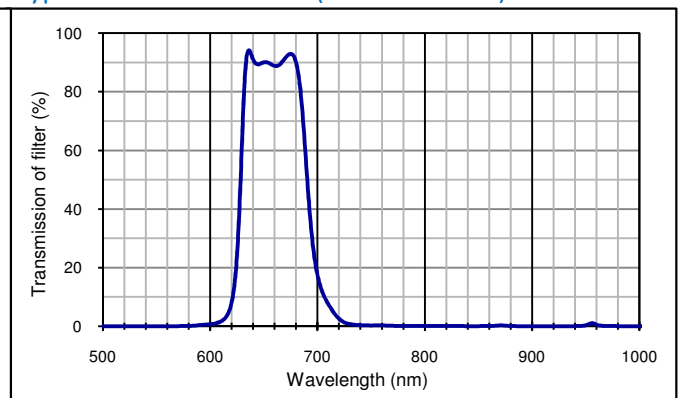

full filter specification upon request

European, International Sales:



International AG

Silicon Sensor International AG  
 Peter-Behrens-Strasse 15  
 12459 Berlin  
 Germany  
 Phone: +49-30-6399-2399  
 Fax: +49-30-6399-23752  
 E-Mail: sales@silicon-sensor.com

USA:



Pacific Silicon Sensor, Inc.  
 5700 Corsa Avuanue #105  
 Westlake Village  
 CA 91362 USA  
 Phone: +1-818-706-3400  
 Fax: +1-818-889-7053  
 E-Mail: sales@pacific-sensor.com



Package dimension, large quantities on reel

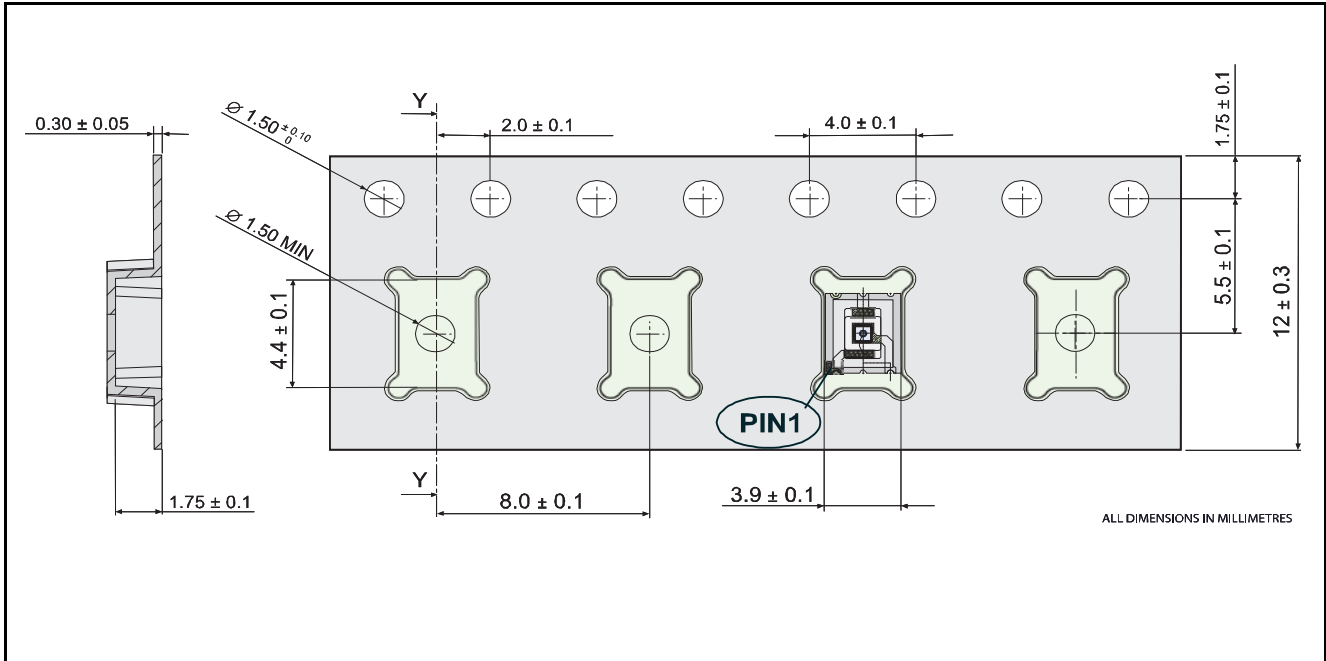

Package dimension, small quantities in trays

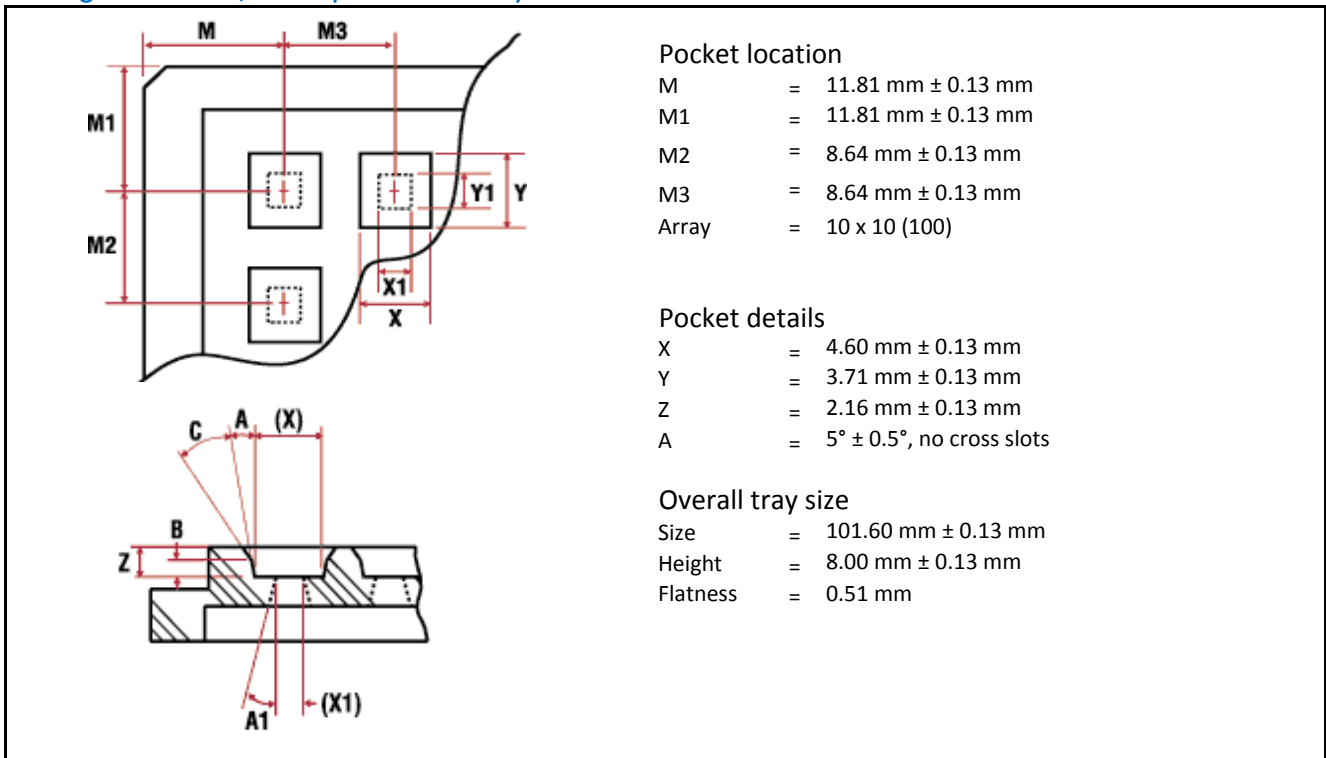

Disclaimer: Due to our strive for continuous improvement, specifications are subject to change within our PCN policy.

European, International Sales:



Silicon Sensor International AG

Silicon Sensor International AG  
 Peter-Behrens-Strasse 15  
 12459 Berlin  
 Germany  
 Phone: +49-30-6399-2399  
 Fax: +49-30-6399-23752  
 E-Mail: sales@silicon-sensor.com

USA:



Pacific Silicon Sensor, Inc.  
 5700 Corsa Avenue #105  
 Westlake Village  
 CA 91362 USA  
 Phone: +1-818-706-3400  
 Fax: +1-818-889-7053  
 E-Mail: sales@pacific-sensor.com