

Features

- APD with 0.008 mm² active area
- Optimized for 550 nm to 750 nm
- Very high sensitivity
- High cut-off frequency
- Ultra low temperature coefficient

Description

Circular active area APD chip with 100 μm diameter. Metal can type hermetic TO52S1 package with clear glass window.

Application

- Laser range finder
- High speed photometry
- High speed optical communications
- Medical equipment

RoHS

2002/95/EC



Absolute maximum ratings

Symbol	Parameter	Min	Max	Unit
T _{STG}	Storage temp	-55	125	°C
T _{OP}	Operating temp	-40	100	°C
M _{max}	Gain (I _{PO} = 1 nA)	200		
I _{PEAK}	Peak DC current		0.25	mA

Spectral response (M = 100)

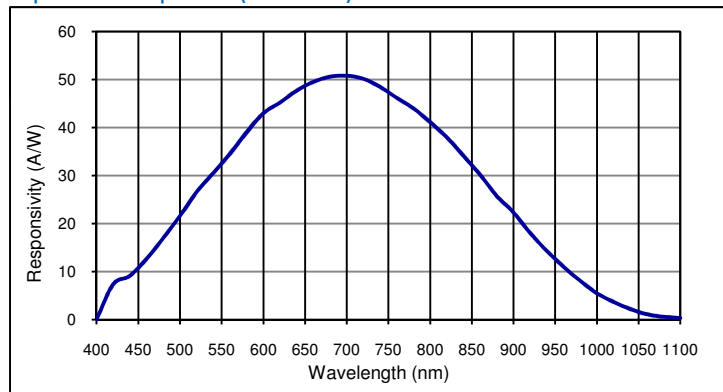

Schematic

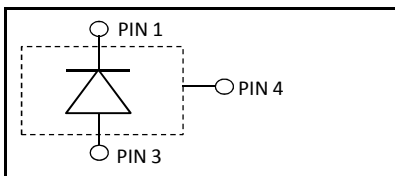

Electro-optical characteristics @ 22°C

Symbol	Characteristic	Test Condition	Min	Typ	Max	Unit
	Active area		diameter 100			μm
	Active area		0.0078			mm ²
I _D	Dark current	M = 100		0.05	0.5	nA
C	Capacitance	M = 100		0.5		pF
	Responsivity	M = 100; λ = 660 nm	45	50		A/W
t _R	Rise time	M = 100; λ = 660 nm; R _L = 50 Ω		0.12		ns
	Cut-off frequency	-3dB, phase shift mode		3		GHz
V _{BR}	Breakdown voltage	I _R = 2 μA, V _{BR} - binning available	60	90	120	V
	Temperature coefficient	Change of V _{BR} with temperature		0.2		V/K
	Excess noise factor	M = 100		2.0		
	Excess noise index	M = 100		0.15		
	N.E.P.	M = 100; λ = 660 nm		2 E-15		W/√Hz
	Noise current	M = 100; λ = 660 nm		0.1		pA/√Hz

European, International Sales:



International AG

Silicon Sensor International AG
 Peter-Behrens-Strasse 15
 12459 Berlin
 Germany
 Phone: +49-30-6399-2399
 Fax: +49-30-6399-23752
 E-Mail: sales@silicon-sensor.com

USA:



Pacific Silicon Sensor, Inc.
 5700 Corsa Avenue #105
 Westlake Village
 CA 91362 USA
 Phone: +1-818-706-3400
 Fax: +1-818-889-7053
 E-Mail: sales@pacific-sensor.com

Quantum efficiency (22 °C)

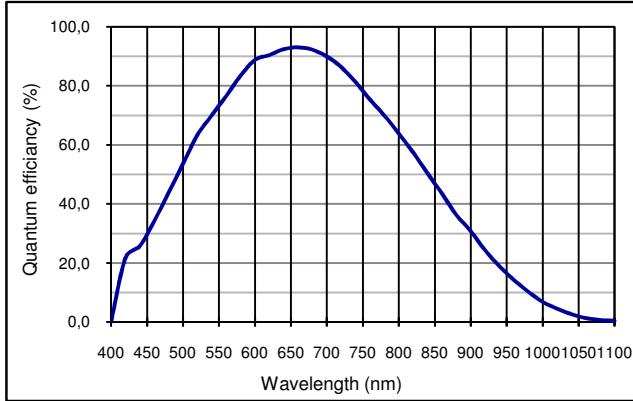

Capacitance as fct of reverse bias (22 °C)

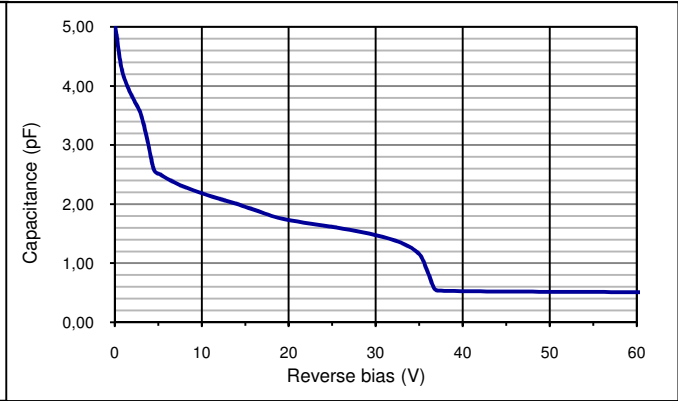

Multiplication as fct of bias (22 °C)

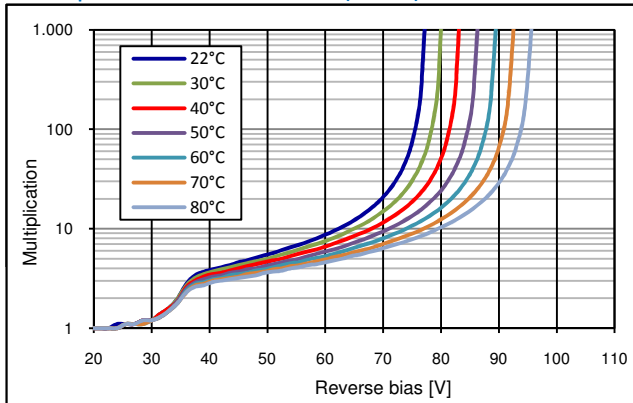

Dark current as fct of bias (22 °C)

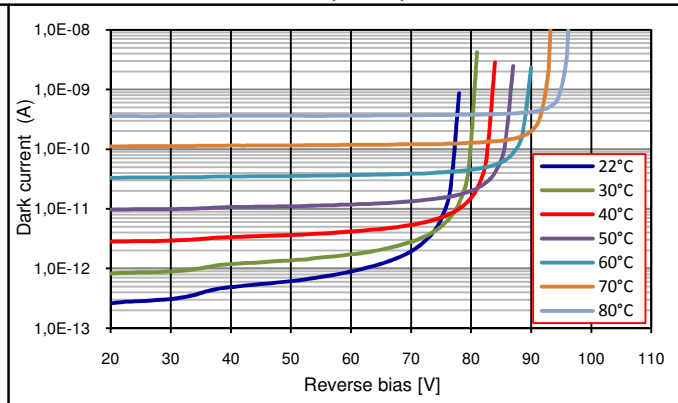

Application hints:

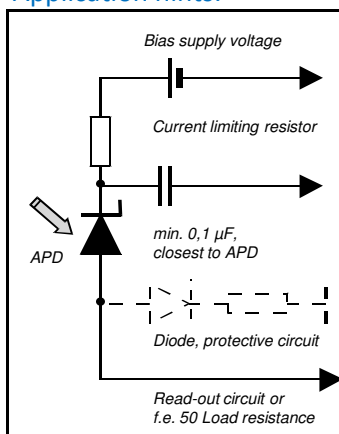

- Current should be limited by a protecting resistor or current limiting - IC inside the power supply
- For low light level applications blocking of ambient light should be used
- For high gain applications bias voltage should be temperature compensated
- Please consider basic ESD protection while handling
- Use low noise read-out - IC
- For further questions please refer to document "Instructions for handling and processing"

Package dimension:

Small quantities: Foam pad, boxed (12 cm x 16.5 cm)

Disclaimer: Due to our strive for continuous improvement, specifications are subject to change within our PCN policy according to JESD46C.

European, International Sales:



Silicon Sensor International AG
 Peter-Behrens-Strasse 15
 12459 Berlin
 Germany
 Phone: +49-30-6399-2399
 Fax: +49-30-6399-23752
 E-Mail: sales@silicon-sensor.com

USA:



Pacific Silicon Sensor, Inc.
 5700 Corsa Avenue #105
 Westlake Village
 CA 91362 USA
 Phone: +1-818-706-3400
 Fax: +1-818-889-7053
 E-Mail: sales@pacific-sensor.com